

镜盒
CASES

4 - 21

清洗液
SPRAY

22 - 24

镜布
MICROFIBER

25 - 31

纸袋
BAGS

32 - 33

设备
EQUIPMENT

35 - 65

设备配件
EQUIPMENT
ACCESSORIES

66 - 94

钳子
PLIERS

95 - 102

螺丝
SCREWS

103 - 105

眼镜配件
GLASSES
ACCESSORIES

106 - 121

镜绳
GLASSES
CHAINS

122 - 126

道具
PROPERTY

128 - 137

镜架
FRAME

139 - 146

镜片
LENS

148 - 153

礼品
GIFTS

155 - 157



TM001



FEATURES

Size	70×107×22mm
Weight	81.5g
Measure Scope	±20
Measure Range	max 0 to 20mm
Reading	0.25



TM004



FEATURES

Size	137×85×137mm
Weight	162.5g
Measure Scope	±20
Measure Range	max 0 to 20mm
Accuracy	0.01
Throat Width	45mm
Reading	0.05



TM005



FEATURES

Size	178×110×36mm
Weight	374g
Measure Scope	±20
Measure Range	max 0 to 20mm
Accuracy	0.01
Throat Width	80mm



TM006

FEATURES

Size	88×75×35mm
Weight	81.5g
Measure Scope	±20
Measure Range	max 0 to 20mm



TM012

FEATURES

Size	264×110×35mm
Weight	386g
Measure Scope	0-150

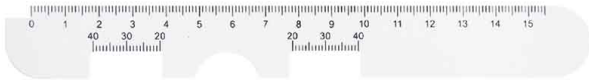

PR001

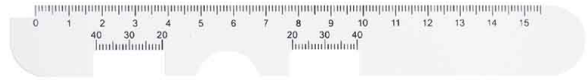

PR002

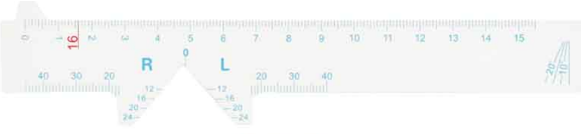

PR003

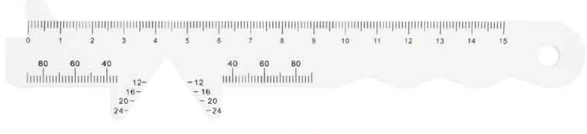

PR004

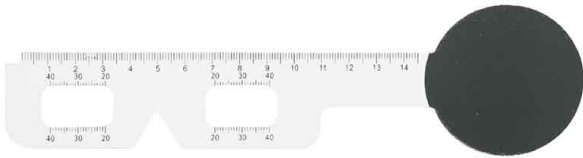

PR005



PR017

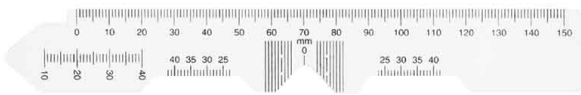

PR007



PR008

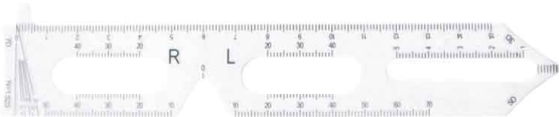

PR010



PR011



PR012



PR013



PR014

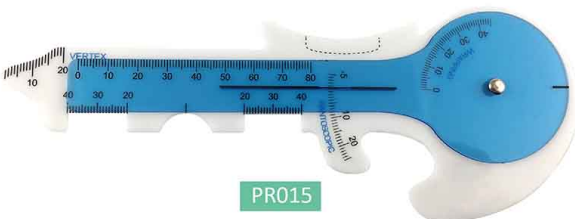

PR015

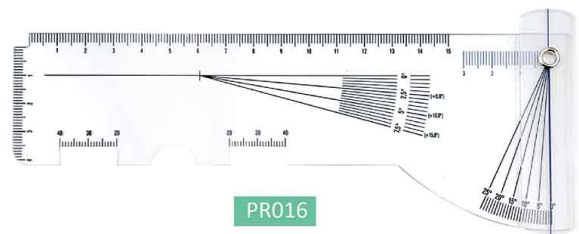

PR016

镜盒

CASES

4 - 21

清洗液

SPRAY

22 - 24

镜布

MICROFIBER

25 - 31

纸袋

BAGS

32 - 33

设备

EQUIPMENT

35 - 65

设备配件

EQUIPMENT

ACCESSORIES

66 - 94

钳子

PLIERS

95 - 102

螺丝

SCREWS

103 - 105

眼镜配件

GLASSES

ACCESSORIES

106 - 121

镜绳

GLASSES

CHAINS

122 - 126

道具

PROPERTY

128 - 137

镜架

FRAME

139 - 146

镜片

LENS

148 - 153

礼品

GIFTS

155 - 157

镜盒
CASES

4 - 21

清洗液
SPRAY

22 - 24

镜布
MICROFIBER

25 - 31

纸袋
BAGS

32 - 33

设备
EQUIPMENT

35 - 65

设备配件
EQUIPMENT
ACCESSORIES

66 - 94

钳子
PLIERS

95 - 102

螺丝
SCREWS

103 - 105

眼镜配件
GLASSES
ACCESSORIES

106 - 121

镜绳
GLASSES
CHAINS

122 - 126

道具
PROPERTY

128 - 137

镜架
FRAME

139 - 146

镜片
LENS

148 - 153

礼品
GIFTS

155 - 157



RGW-1

100/35wv/14
手磨机CP-7-35WV



RGW-2

100/35w/14
手磨机CP-7-35W



RGW-3

100/20/14
手磨机CP-7-20



RGW-4

100/30/14
手磨机CP-7-30



RGW-5

114/20/16
铁芯/iron core



RGW-6

110/20/16



RGW-7

170/20/14



RGW-8

150/20/20
双轮手磨机砂轮带六孔



RGW-8V

150/25v/20
双轮手磨机砂轮带六孔V型



RGW-9

150/25v/14
双轮手磨机砂轮V型



RGW-10

150/20/14
双轮手磨机砂轮



RGW-11

100/16/17
PC



RGW-12

100/16/17
树脂/Resin



RGW-13

100/11/17
抛光/Polishing



RGW-14

100/15/17
玻璃粗磨轮/Resin



RGW-15

100/23V/17



LF-8201

经联 田洼大吸盘
JINGLIAN



LF-8202

朗驰 田洼中号吸盘
LANGCHI



LF-8203

精功 田洼椭圆形吸盘
JINGGONG

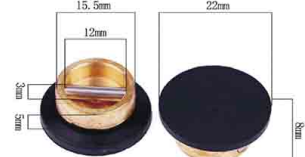

LF-8204

经联 田洼平吸盘
JINGLIAN

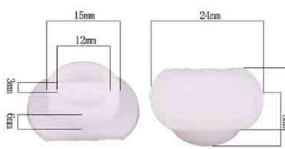

LF-8205

经联 田洼塑料扁吸盘
JINGLIAN



LF-8206

精功 田洼塑料大吸盘
JINGGONG

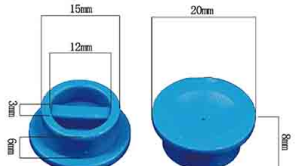

LF-8207

经联 田洼塑料小吸盘
JINGLIAN



LF-8208

田洼小头小脚吸盘
TIANWA



LF-8209

田洼小头小脚扁吸盘
TIANWA

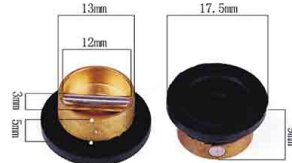

LF-8210

田洼小头小脚平吸盘
TIANWA

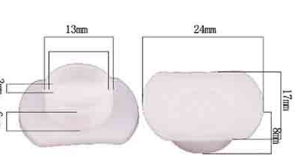

LF-8211

田洼小脚塑料扁吸盘
TIANWA

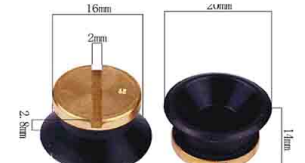

LF-8212

维高小号吸盘
VIGO



LF-8213

南韩大吸盘
NANHAN

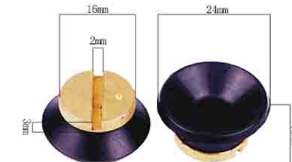

LF-8214

南韩高脚大吸盘
NANHAN



LF-8215

雄博吸盘
SUPORE

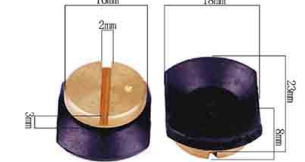

LF-8216

威柯扁吸盘
VICO



LF-8217

南韩椭圆吸盘
NANHAN

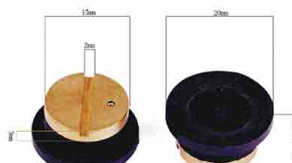

LF-8218

南韩平吸盘
NANHAN

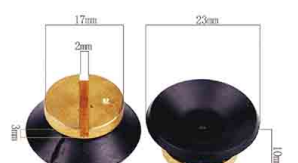

LF-8219

维科吸盘
VICO

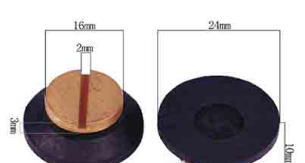

LF-8220

维高大号平吸盘
VIGO

镜盒

CASES

4 - 21

清洗液

SPRAY

22 - 24

镜布

MICROFIBER

25 - 31

纸袋

BAGS

32 - 33

设备

EQUIPMENT

35 - 65

设备配件

EQUIPMENT

ACCESSORIES

66 - 94

钳子

PLIERS

95 - 102

螺丝

SCREWS

103 - 105

眼镜配件

GLASSES

ACCESSORIES

106 - 121

镜绳

GLASSES

CHAINS

122 - 126

道具

PROPERTY

128 - 137

镜架

FRAME

139 - 146

镜片

LENS

148 - 153

礼品

GIFTS

155 - 157



LF-8221

天乐 磨得美吸盘
TIANLE



LF-8222

雄博 南韩塑料扁吸盘
SUPORE

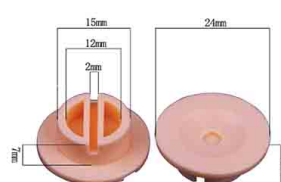

LF-8223

南韩大圆塑料平吸盘
NANHAN

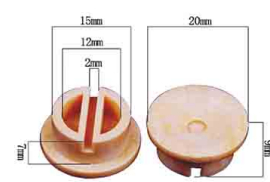

LF-8224

新世纪 南韩小圆塑料平吸盘
XINSHIJI

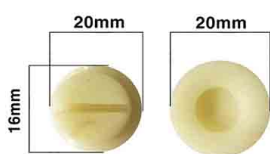

LF-8225

雄博 南韩塑料平吸盘
SUPORE

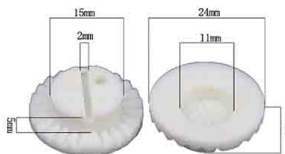

LF-8226

百利奥大吸盘
BERIO

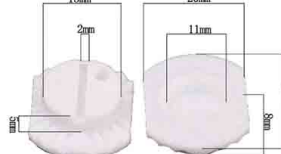

LF-8227

百利奥扁吸盘
BERIO

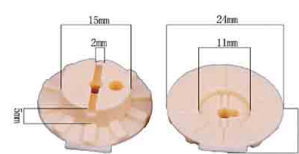

LF-8228

依视路塑料吸盘
ESSILOR



LF-8229

依视路塑料扁吸盘
ESSILOR

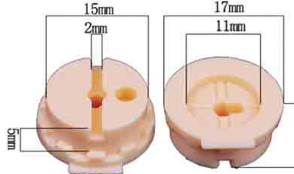

LF-8230

依视路塑料小圆吸盘
ESSILOR

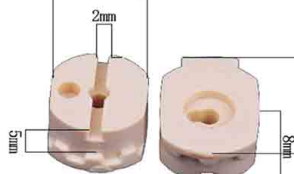

LF-8231

依视路塑料扁吸盘
ESSILOR

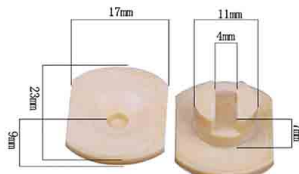

LF-8232

依视路塑料扁吸盘
ESSILOR



LF-8233

新世纪 健龙达吸盘
XINSHIJI

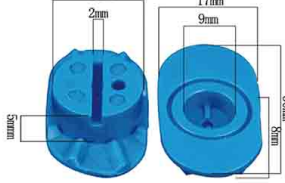

LF-8234

南韩塑料扁吸盘
NANHAN



LF-8235

尼德克大号吸盘
NIDEK



LF-8236

尼德克中号吸盘
NIDEK



LF-8237

尼德克中号平吸盘
NIDEK



LF-8238

尼德克小号平吸盘
NIDEK

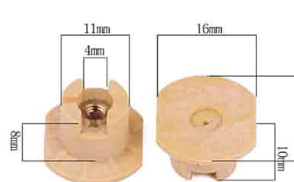

LF-8239

贝佳纳塑料吸盘
BERGENA

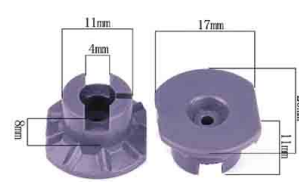

LF-8240

尼德克塑料扁吸盘
NIDEK

镜盒
CASES

4 - 21

清洗液
SPRAY

22 - 24

镜布
MICROFIBER

25 - 31

纸袋
BAGS

32 - 33

设备
EQUIPMENT

35 - 65

设备配件
EQUIPMENT
ACCESSORIES

66 - 94

钳子
PLIERS

95 - 102

螺丝
SCREWS

103 - 105

眼镜配件
GLASSES
ACCESSORIES

106 - 121

镜绳
GLASSES
CHAINS

122 - 126

道具
PROPERTY

128 - 137

镜架
FRAME

139 - 146

镜片
LENS

148 - 153

礼品
GIFTS

155 - 157

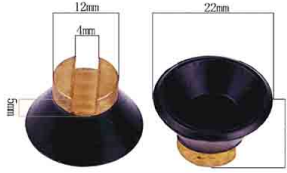

LF-8241

依视路大号吸盘
ESSILOR



LF-8242

依视路椭圆吸盘
ESSILOR



LF-8243

依视路中号吸盘
ESSILOR



LF-8244

依视路中号平吸盘
ESSILOR

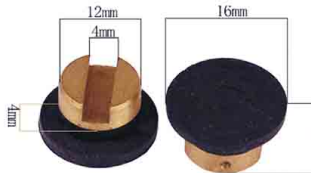

LF-8245

依视路椭圆吸盘
ESSILOR



LF-8246

依视路小头吸盘
ESSILOR



LF-8247

百利奥大号吸盘
BERIO



LF-8248

百利奥椭圆吸盘
BERIO



LF-8249

百利奥小头吸盘
BERIO

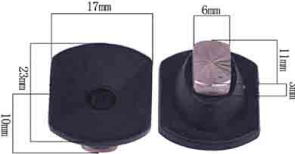

LF-8250

百利奥扁平吸盘
BERIO

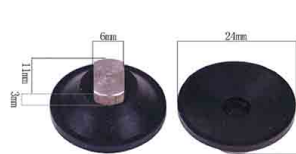

LF-8251

百利奥大号吸盘
BERIO



LF-8252

百利奥小号吸盘
BERIO

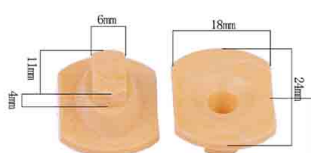

LF-8253

百利奥塑料扁吸盘
BERIO

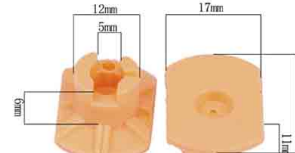

LF-8254

依视路吸盘
ESSILOR



LF-8255

百利奥磁性吸盘
BERIO

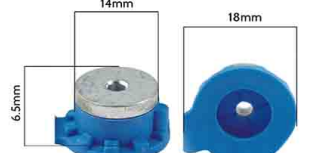

LF-8256

百利奥小号磁性吸盘
BERIO

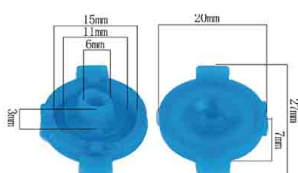

LF-8257

依视路塑料吸盘
ESSILOR

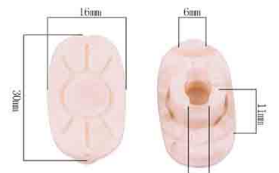

LF-8258

尼德克吸盘
NIDEK

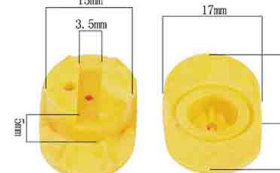

LF-8259

尼德克吸盘
NIDEK

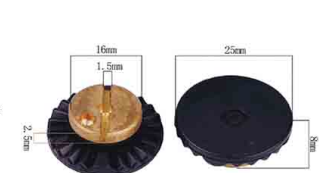

LF-8260

百利奥吸盘
BERIO

镜盒

CASES

4 - 21

清洗液

SPRAY

22 - 24

镜布

MICROFIBER

25 - 31

纸袋

BAGS

32 - 33

设备

EQUIPMENT

35 - 65

设备配件

EQUIPMENT

ACCESSORIES

66 - 94

钳子

PLIERS

95 - 102

螺丝

SCREWS

103 - 105

眼镜配件

GLASSES

ACCESSORIES

106 - 121

镜绳

GLASSES

CHAINS

122 - 126

道具

PROPERTY

128 - 137

镜架

FRAME

139 - 146

镜片

LENS

148 - 153

礼品

GIFTS

155 - 157

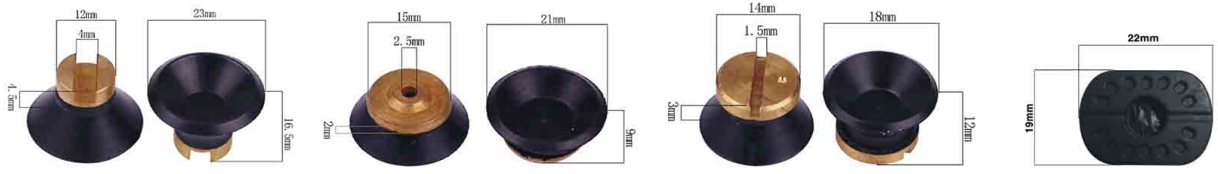

LF-8261 尼德克加厚吸盘 NIDEK
LF-8262 打孔机吸盘
LF-8263 维高小头小脚吸盘 VIGO
LF-8264 精功夹头 JINGGONG



LF-8264-1 经联夹头 JINGLIAN
LF-8265 朗驰 LANGCHI
LF-8266 威柯 VICO
LF-8267 雄博 SUPORE
LF-8268 健达 JIANDA

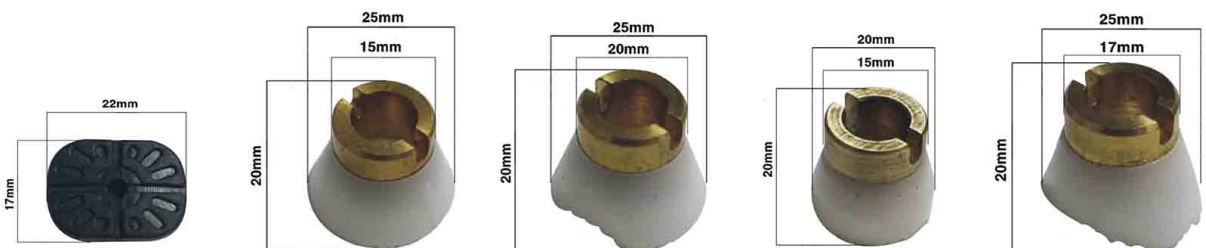

LF-8268-1 健达 JIANDA
LF-8270 尼德克 NIDEK
LF-8270-1 尼德克 NIDEK
LF-8270-2 尼德克 NIDEK
LF-8270-3 尼德克 NIDEK



LF-8271 尼德克 NIDEK
LF-8273 尼德克 NIDEK
LF-8228-1 依视路 ESSILOR
LF-8231-1 依视路 ESSILOR



LF-8274 经联 JINGLIAN
LF-8276 精功 JINGGONG
LF-8277 精功 JINGGONG
OA093
OA094
OA093A
OA094A

- 镜盒 CASES
- 4-21
- 清洗液 SPRAY
- 22-24
- 镜布 MICROFIBER
- 25-31
- 纸袋 BAGS
- 32-33
- 设备 EQUIPMENT
- 35-65
- 设备配件 EQUIPMENT ACCESSORIES
- 66-94
- 钳子 PLIERS
- 95-102
- 螺丝 SCREWS
- 103-105
- 眼镜配件 GLASSES ACCESSORIES
- 106-121
- 镜绳 GLASSES CHAINS
- 122-126
- 道具 PROPERTY
- 128-137
- 镜架 FRAME
- 139-146
- 镜片 LENS
- 148-153
- 礼品 GIFTS
- 155-157

常用精磨片、抛光片规格示意图(可特殊定制)

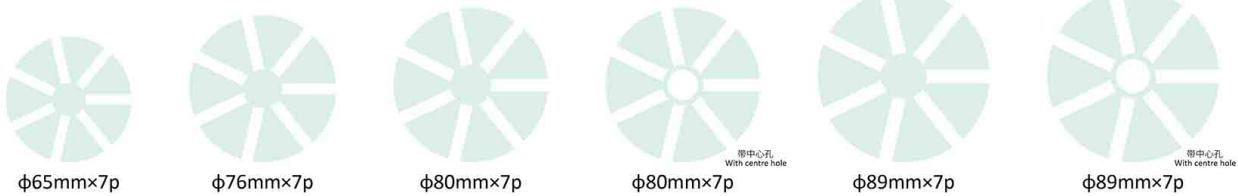

ALL OTHER SHAPES AND SIZES ARE AVAILABLE UPON REQUEST

加工树脂镜片-两步法精磨片



JM001A

品名 Name	第一步精磨片(棕色)JN系列 1st Fine Brown JN Series
规格 Description	φ76mm×7p
数量 Quantity	500pcs/roll



JM001C

品名 Name	第一步精磨片(棕色)GX系列 1st Fine Brown GX Series
规格 Description	φ76mm×7p
数量 Quantity	500pcs/roll



JM002A

品名 Name	第二步精磨片(粉色)3MIC系列 2nd Fine Pink 3MIC Series
规格 Description	φ76mm×6p
数量 Quantity	500pcs/roll



JM002C

品名 Name	第二步精磨片(蓝色)3MIC系列 2nd Fine Blue 3MIC Series
规格 Description	φ76mm×6p
数量 Quantity	500pcs/roll

加工树脂镜片-二步法精磨片



JM002D

品名 Name	精磨片(灰色) Finishing Pad Grey
规格 Description	φ76mm×7p
数量 Quantity	200pcs/roll

加工树脂镜片-一步法精磨片



JM001E

品名 Name	精磨片(棕色)JN系列 Finishing Pad Brown JN Series
规格 Description	φ76mm×7p
数量 Quantity	250pcs/roll

加工CR-39高折射率镜片、PC片-抛光片



JM003A

品名 Name	抛光片(白色)EF系列 Polishing Pad White EF Series
规格 Description	φ76mm×7p
数量 Quantity	250pcs/roll



JM003C

品名 Name	抛光片(黄色)EF系列 Polishing Pad Yellow EF Series
规格 Description	φ76mm×6p
数量 Quantity	250pcs/roll

RX车房加工用耗材相关产品



C-99300005

品名 Name	3M1641保护胶纸 3M1641 Surface Saver Tape
规格 Description	10cm×46m/roll
数量 Quantity	1 roll



C-99300005W

品名 Name	3M1641保护胶纸 3M1641 Surface Saver Tape
规格 Description	10cm×46m/roll
数量 Quantity	1 roll



C-92000442

品名 Name	47°C/49°C进口低温合金 47°C/49°C imported low temperature alloy
规格 Description	1kg/pc
数量 Quantity	1pc

镜盒 CASES	4 - 21
清洗液 SPRAY	22 - 24
镜布 MICROFIBER	25 - 31
纸袋 BAGS	32 - 33
设备 EQUIPMENT	35 - 65
设备配件 EQUIPMENT ACCESSORIES	66 - 94
钳子 PLIERS	95 - 102
螺丝 SCREWS	103 - 105
眼镜配件 GLASSES ACCESSORIES	106 - 121
镜绳 GLASSES CHAINS	122 - 126
道具 PROPERTY	128 - 137
镜架 FRAME	139 - 146
镜片 LENS	148 - 153
礼品 GIFTS	155 - 157



FEATURES

1. Made with only the highest quality materials
2. Precisely designed color-coded bases
3. Technically advanced polishing surface with 1st-step and 2nd-step material offerings
4. An easy 10-tool pack

Part	Description	Lens Material	Curve	Package
GWSP1B75	1st-step white pad / blue base	All Materials	75	10pcs/box
GWSP1R150	1st-step white pad / red base	All Materials	150	10pcs/box
GWSP1G600	1st-step white pad / grey base	All Materials	600	10pcs/box
GWSP2B75	2nd-step Black pad / blue base	Poly/Trivex	75	10pcs/box
GWSP2R150	2nd-step Black pad / red base	Poly/Trivex	150	10pcs/box
GWSP2G600	2nd-step Black pad / grey base	Poly/Trivex	600	10pcs/box



FEATURES

1. Made with only the highest quality materials
2. Available working range from 1 to 13dpt
3. Easy to operate
4. Suitable for all lens: spherical, toric and free-form surface
5. An easy 10-tool pack

Part	Curve	Package	Part	Curve	Package
GWLP1-1A	1	10pcs/box	GWLP2-1A	1	10pcs/box
GWLP1-3A	3	10pcs/box	GWLP2-3A	3	10pcs/box
GWLP1-5A	5	10pcs/box	GWLP2-5A	5	10pcs/box
GWLP1-7A	7	10pcs/box	GWLP2-7A	7	10pcs/box
GWLP1-9A	9	10pcs/box	GWLP2-9A	9	10pcs/box
GWLP1-11A	11	10pcs/box	GWLP2-11A	11	10pcs/box
GWLP1-13A	13	10pcs/box	GWLP2-13A	13	10pcs/box

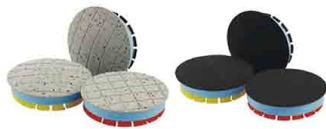

FEATURES

1. Used for Multi-tool Tori-lab Freestyle
2. Different curve option: R45, R75, R250
3. 2-type pads are available: PU and Black Felt

Part	Description	Lens Material	Curve
GWOP1R45	PU pad / black base	All Materials	R45
GWOP1R75	PU pad / black base	All Materials	R75
GWOP1R250	PU pad / black base	All Materials	R250
GWOP2R45	black pad / black base	Poly/Trivex	R45
GWOP2R75	black pad / yellow base	Poly/Trivex	R75
GWOP2R250	black pad / black base	Poly/Trivex	R250



FEATURES

1. Used for FEM-tool in RX-production
2. 2-diameters/Curves available:78/R45mm and 65/R50mm
3. 2-type pads are available:PU and Black Felt

Part	Description	Lens Material	Curve
GWOP3-78	PU	78mm	R45
GWOP3-65	PU	65mm	R50
GWOP4-78	black felt	78mm	R45
GWOP4-65	black felt	65mm	R50



Part	Lens Material	Volume	Package
GWPL6830	All materials	1 gallon	4 bottles/Box

FEATURES

1. PH:3.0-3.6
2. Color:White
3. Particle Size:(D50)2.0±0.2um
4. Baume: 18±1°
5. Recommended Processing temperature 60-65 °F (15-18 °C)



FEATURES

1. Eco-friendly PET materia
2. Easy to use 100% lens protection
3. Sharp edge free design
4. Low cost available to customize with your own logo



FEATURES

1. Left part: GWRC-L Right part: GWRC-R
2. Latest design great durability consistent performance
3. Easy to install and uninstall ideal for use in fining and polishing cycles



FEATURES

1. 2 types: Long and short
2. Bellow material: Durable rubber material
3. Suitable fit and great performance Easy install and uninstall design

Blocking Pads



Usage



1. Clean the lens



2. Apply the discs



3. Apply the pad



4. Final assembly

Attention



1

1. Stick on the suction cup with the lucency side



2

2. Stick on the lens with the silver side



3

3. Fully jointed with the lens surface

镜盒
CASES

4 - 21

清洗液
SPRAY

22 - 24

镜布
MICROFIBER

25 - 31

纸袋
BAGS

32 - 33

设备
EQUIPMENT

35 - 65

设备配件
EQUIPMENT
ACCESSORIES

66 - 94

钳子
PLIERS

95 - 102

螺丝
SCREWS

103 - 105

眼镜配件
GLASSES
ACCESSORIES

106 - 121

镜绳
GLASSES
CHAINS

122 - 126

道具
PROPERTY

128 - 137

镜架
FRAME

139 - 146

镜片
LENS

148 - 153

礼品
GIFTS

155 - 157



OA029

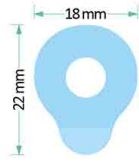

OA029A



OA029B

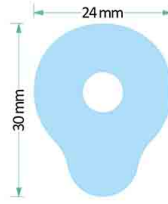

OA029C

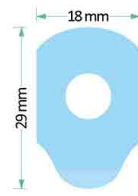

OA029D

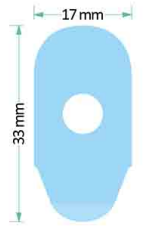

OA029E



T-OA029

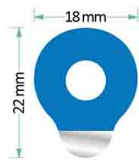

T-OA029A

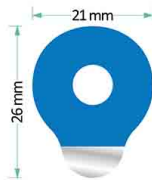

T-OA029B

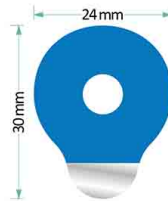

T-OA029C

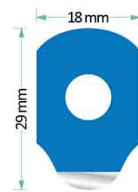

T-OA029D

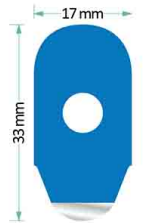

T-OA029E



R-OA029

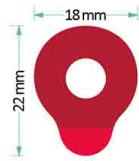

R-OA029A

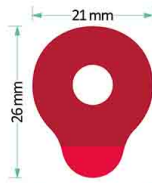

R-OA029B



R-OA029C

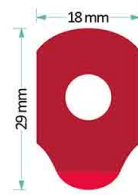

R-OA029D

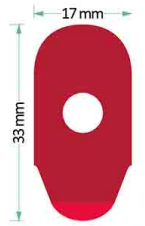

R-OA029E



B-OA029



B-OA029A

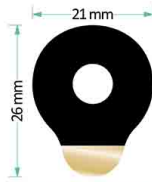

B-OA029B

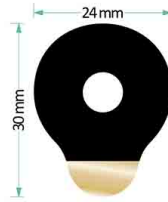

B-OA029C

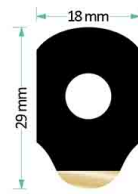

B-OA029D

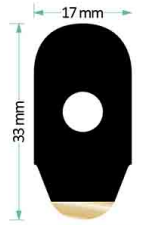

B-OA029E



W-OA029



W-OA029A

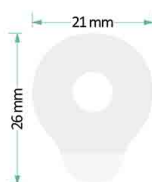

W-OA029B

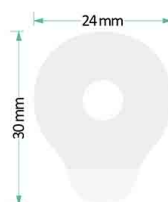

W-OA029C

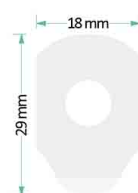

W-OA029D

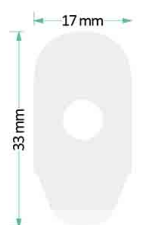

W-OA029E

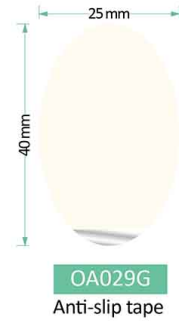
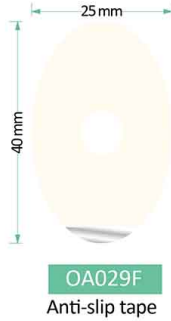

Blocking pads
can be
customized

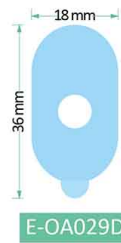

ESSILOR

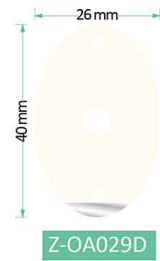
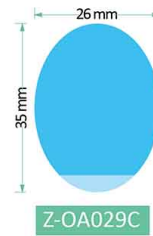
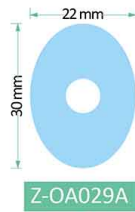

ZEISS

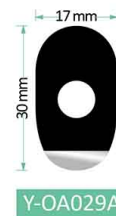
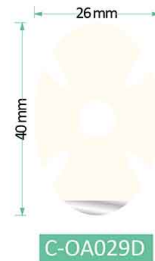
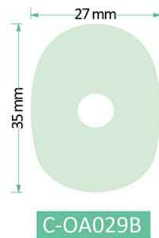

- 镜盒
CASES
- 4 - 21
- 清洗液
SPRAY
- 22 - 24
- 镜布
MICROFIBER
- 25 - 31
- 纸袋
BAGS
- 32 - 33
- 设备
EQUIPMENT
- 35 - 65
- 设备配件
EQUIPMENT
ACCESSORIES
- 66 - 94
- 钳子
PLIERS
- 95 - 102
- 螺丝
SCREWS
- 103 - 105
- 眼镜配件
GLASSES
ACCESSORIES
- 106 - 121
- 镜绳
GLASSES
CHAINS
- 122 - 126
- 道具
PROPERTY
- 128 - 137
- 镜架
FRAME
- 139 - 146
- 镜片
LENS
- 148 - 153
- 礼品
GIFTS
- 155 - 157

镜盒
CASES

4 - 21

清洗液
SPRAY

22 - 24

镜布
MICROFIBER

25 - 31

纸袋
BAGS

32 - 33

设备
EQUIPMENT

35 - 65

设备配件
EQUIPMENT
ACCESSORIES

66 - 94

钳子
PLIERS

95 - 102

螺丝
SCREWS

103 - 105

眼镜配件
GLASSES
ACCESSORIES

106 - 121

镜绳
GLASSES
CHAINS

122 - 126

道具
PROPERTY

128 - 137

镜架
FRAME

139 - 146

镜片
LENS

148 - 153

礼品
GIFTS

155 - 157



13×3.5mm
孔间距: 9.5cm
OA-009 Jaw Paper
下巴纸

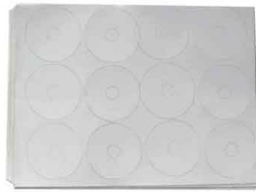

OA-031 Protect Film For Lens
镜片用保护膜

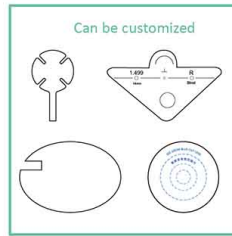

OA-033 Protect Film For Lens
镜片用保护膜



幅面: 57mm
长度: 30m
OA-035A Printing Paper
打印纸



幅面: 57mm
长度: 40m
OA-035B Printing Paper
打印纸



幅面: 57mm
长度: 50m
OA-035C Printing Paper
打印纸



CT-8403 Polishing Wax
抛光蜡



OA089 243 threadlocker
243螺纹紧固剂



OA090 atomic ink
原子印油



OA091 401 glue
401胶水



OA092 GS glue
GS胶水



CT-8403A Polishing Wax
抛光蜡



CT-8503 Polishing Cloth Wheel
抛光用布轮



CT-8504 Polishing Woolwheel
抛光用羊毛轮



CT-8505 Polishing Cloth Wheel
抛光用布轮



CT-8505A Polishing Cloth Wheel
抛光用布轮



直径/Diameter: 69mm
CT-8506B Grooving Machine Belt
开槽机皮带



直径/Diameter: 80mm
CT-8506 Drilling Machine Belt
打孔机皮带



直径/Diameter: 69mm
CT-8507 Lens Edger Timing Belt
SJG磨边同步带



直径/Diameter: 120mm
CT-8508 Hand Lens Edger Belt
手磨机皮带



R-B01A

Model No.	Product Name	Quantity	Photo
R-AB923	Plier	1 pc	
R-AB924	Plier	1 pc	
R-AB931	Plier	1 pc	
/	Spare Jaws (AB923)	1 pair	
/	Spare Jaws (AB924)	1 pair	



R-B01C

Model No.	Product Name	Quantity	Photo
R-AB08	Plier	1 pc	
R-AB14	Plier	1 pc	
R-AB21	Plier	1 pc	
R-AB923	Plier	1 pc	
R-AB924	Plier	1 pc	
R-AB931	Plier	1 pc	



R-B01B

Model No.	Product Name	Quantity	Photo
R-AB923	Plier	1 pc	
R-AB924	Plier	1 pc	
R-AB931	Plier	1 pc	
QS-031	Screwdriver	1 pc	1.5
QS-031	Screwdriver	1 pc	1.6
QS-031	Screwdriver	1 pc	1.8
QS-031	Screwdriver	1 pc	1.8
QS-031	Screwdriver	1 pc	2.32
QS-031	Screwdriver	1 pc	2.57
QS-031	Screwdriver	1 pc	2.52
QS-031	Screwdriver	1 pc	2.82



R-B01D

Model No.	Product Name	Quantity	Photo
R-AB08	Plier	1 pc	
R-AB14	Plier	1 pc	
R-AB21	Plier	1 pc	
QS-031	Screwdriver	1 pc	1.5
QS-031	Screwdriver	1 pc	1.6
QS-031	Screwdriver	1 pc	1.8
QS-031	Screwdriver	1 pc	1.8
QS-031	Screwdriver	1 pc	2.32
QS-031	Screwdriver	1 pc	2.57
QS-031	Screwdriver	1 pc	2.52
QS-031	Screwdriver	1 pc	2.82

- 镜盒 CASES
- 4 - 21
- 清洗液 SPRAY
- 22 - 24
- 镜布 MICROFIBER
- 25 - 31
- 纸袋 BAGS
- 32 - 33
- 设备 EQUIPMENT
- 35 - 65
- 设备配件 EQUIPMENT ACCESSORIES
- 66 - 94
- 钳子 PLIERS
- 95 - 102
- 螺丝 SCREWS
- 103 - 105
- 眼镜配件 GLASSES ACCESSORIES
- 106 - 121
- 镜绳 GLASSES CHAINS
- 122 - 126
- 道具 PROPERTY
- 128 - 137
- 镜架 FRAME
- 139 - 146
- 镜片 LENS
- 148 - 153
- 礼品 GIFTS
- 155 - 157

镜盒
CASES

4 - 21

清洗液
SPRAY

22 - 24

镜布
MICROFIBER

25 - 31

纸袋
BAGS

32 - 33

设备
EQUIPMENT

35 - 65

设备配件
EQUIPMENT
ACCESSORIES

66 - 94

钳子
PLIERS

95 - 102

螺丝
SCREWS

103 - 105

眼镜配件
GLASSES
ACCESSORIES

106 - 121

镜绳
GLASSES
CHAINS

122 - 126

道具
PROPERTY

128 - 137

镜架
FRAME

139 - 146

镜片
LENS

148 - 153

礼品
GIFTS

155 - 157



SL009

Model No.	Product Name	Quantity	Photo
R-AB923	Plier	1 pc	
R-AB924	Plier	1 pc	
R-AB931	Plier	1 pc	
QS-031	Screwdriver	1 pc	1.6
QS-031	Screwdriver	1 pc	1.4
QS-031	Screwdriver	1 pc	2.0
QS-031	Screwdriver	1 pc	1.8
QS-031	Screwdriver	1 pc	2.02
QS-031	Screwdriver	1 pc	2.32
QS-031	Screwdriver	1 pc	2.52
QS-031	Screwdriver	1 pc	2.56

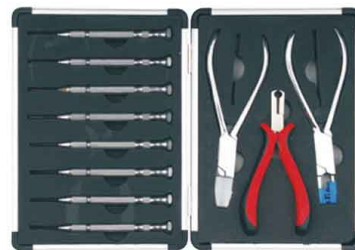

SL009-A

Model No.	Product Name	Quantity	Photo
PT002	Plier	1 pc	
PT008	Plier	1 pc	
R-AB931	Plier	1 pc	
QS-031	Screwdriver	1 pc	1.6
QS-031	Screwdriver	1 pc	1.4
QS-031	Screwdriver	1 pc	2.0
QS-031	Screwdriver	1 pc	1.8
QS-031	Screwdriver	1 pc	2.02
QS-031	Screwdriver	1 pc	2.32
QS-031	Screwdriver	1 pc	2.52
QS-031	Screwdriver	1 pc	2.56



SL009-B

Model No.	Product Name	Quantity	Photo
PT004	Plier	1 pc	
PT015	Plier	1 pc	
PT016	Plier	1 pc	
QS-031	Screwdriver	1 pc	1.6
QS-031	Screwdriver	1 pc	1.4
QS-031	Screwdriver	1 pc	2.0
QS-031	Screwdriver	1 pc	1.8
QS-031	Screwdriver	1 pc	2.02
QS-031	Screwdriver	1 pc	2.32
QS-031	Screwdriver	1 pc	2.52
QS-031	Screwdriver	1 pc	2.56



R-B012



R-B013



R-B014



R-B015



R-B017D



R-B017A



R-B08



R-B017B



R-B017C



R-B010



SS001

- 1.6 / 1.8
- + 1.5 / 1.8
- M2.02 / M2.32 / M2.57
- + M2.52



SS016

- 1.5 / 1.8
- + 1.8
- M2.32 / M2.57
- + M2.52 / M2.82



SS002

- 1.6 / 1.8
- + 1.5 / 1.8
- M2.02 / M2.32 / M2.57
- + M2.52 / M2.82



SS011

- 1.8
- + 1.5 / 1.8
- M2.32 / M2.57
- + M2.52 / M2.82



SS012

- 1.5 / 1.8
- + 1.8
- M2.32 / M2.57
- + M2.52 / M2.82



SS013

- 1.6 / 1.8
- + 1.5 / 1.8
- M2.02 / M2.32 / M2.57
- + M2.52 / M2.82



SS015

- 1.6 / 1.8
- + 1.5 / 1.8
- M2.02 / M2.32 / M2.57
- + M2.52 / M2.82



SS017

- 1.6 / 1.8
- + 1.5 / 1.8
- M2.02 / M2.32 / M2.57
- + M2.52 / M2.82

镜盒
CASES

4 - 21

清洗液
SPRAY

22 - 24

镜布
MICROFIBER

25 - 31

纸袋
BAGS

32 - 33

设备
EQUIPMENT

35 - 65

设备配件
EQUIPMENT
ACCESSORIES

66 - 94

钳子
PLIERS

95 - 102

螺丝
SCREWS

103 - 105

眼镜配件
GLASSES
ACCESSORIES

106 - 121

镜绳
GLASSES
CHAINS

122 - 126

道具
PROPERTY

128 - 137

镜架
FRAME

139 - 146

镜片
LENS

148 - 153

礼品
GIFTS

155 - 157

镜盒
CASES

4 - 21

清洗液
SPRAY

22 - 24

镜布
MICROFIBER

25 - 31

纸袋
BAGS

32 - 33

设备
EQUIPMENT

35 - 65

设备配件
EQUIPMENT
ACCESSORIES

66 - 94

钳子
PLIERS

95 - 102

螺丝
SCREWS

103 - 105

眼镜配件
GLASSES
ACCESSORIES

106 - 121

镜绳
GLASSES
CHAINS

122 - 126

道具
PROPERTY

128 - 137

镜架
FRAME

139 - 146

镜片
LENS

148 - 153

礼品
GIFTS

155 - 157



SL001



SL002



SL003



SL005



SL006



SL010



SL013



SL014



SL020



SL021



SL022



SL026



镜盒 CASES	4 - 21
清洗液 SPRAY	22 - 24
镜布 MICROFIBER	25 - 31
纸袋 BAGS	32 - 33
设备 EQUIPMENT	35 - 65
设备配件 EQUIPMENT ACCESSORIES	66 - 94
钳子 PLIERS	95 - 102
螺丝 SCREWS	103 - 105
眼镜配件 GLASSES ACCESSORIES	106 - 121
镜绳 GLASSES CHAINS	122 - 126
道具 PROPERTY	128 - 137
镜架 FRAME	139 - 146
镜片 LENS	148 - 153
礼品 GIFTS	155 - 157

镜盒
CASES
4 - 21

清洗液
SPRAY
22 - 24

镜布
MICROFIBER
25 - 31

纸袋
BAGS
32 - 33

设备
EQUIPMENT
35 - 65

设备配件
EQUIPMENT
ACCESSORIES
66 - 94

钳子
PLIERS
95 - 102

螺丝
SCREWS
103 - 105

眼镜配件
GLASSES
ACCESSORIES
106 - 121

镜绳
GLASSES
CHAINS
122 - 126

道具
PROPERTY
128 - 137

镜架
FRAME
139 - 146

镜片
LENS
148 - 153

礼品
GIFTS
155 - 157















Sample Product No. 样品产品规则:

A	-301-	C1
Clip 夹头	Shape 片型	Color 颜色









Clip 夹头

 A 52×36mm	 B 32×22mm	 C 49×26mm
 D 23×18mm	 E 28×21mm	 F 28×20mm
 G 53×35mm	 H 29×21mm	 I 52×35mm

Shape 片型

 301 60×42mm	 870 59×40mm	 872 60×35mm	 873 60×52mm	 1001M 59×42mm
 1403 58×44mm	 1408 59×44mm	 1861 57×43mm	 5003F 59×52mm	 6260 60×36mm

Color 颜色

 C1 black	 C2 dark grey	 C3 light grey	 C4 brown	 C5 G15
 C6 night vision yellow	 C7 blue cut	 C8 3D	 C9 burgundy	 C10 mirror blue

- 镜盒 CASES 4 - 21
- 清洗液 SPRAY 22 - 24
- 镜布 MICROFIBER 25 - 31
- 纸袋 BAGS 32 - 33
- 设备 EQUIPMENT 35 - 65
- 设备配件 EQUIPMENT ACCESSORIES 66 - 94
- 钳子 PLIERS 95 - 102
- 螺丝 SCREWS 103 - 105
- 眼镜配件 GLASSES ACCESSORIES 106 - 121
- 镜绳 GLASSES CHAINS 122 - 126
- 道具 PROPERTY 128 - 137
- 镜架 FRAME 139 - 146
- 镜片 LENS 148 - 153
- 礼品 GIFTS 155 - 157

镜盒 CASES					
4 - 21					
清洗液 SPRAY					
22 - 24					
镜布 MICROFIBER					
25 - 31					
纸袋 BAGS					
32 - 33					
设备 EQUIPMENT					
35 - 65					
设备配件 EQUIPMENT ACCESSORIES					
66 - 94					
钳子 PLIERS					
95 - 102					
螺丝 SCREWS					
103 - 105					
眼镜配件 GLASSES ACCESSORIES					
106 - 121					
镜绳 GLASSES CHAINS					
122 - 126					
道具 PROPERTY					
128 - 137					
镜架 FRAME					
139 - 146					
镜片 LENS					
148 - 153					
礼品 GIFTS					
155 - 157					



A



B



C



D



E



A-301-C5



A-870-C10



A-872-C9



A-1001M-C4



A-1403-C3



A-1408-C6



A-5003F-C7



A-6260-C8



B-301-C4



B-870-C6



B-872-C5



B-1001M-C9



B-1403-C8



B-1408-C10



B-5003F-C3



B-6260-C1



C-301-C3



C-870-C9



C-872-C1



C-1001M-C10



C-1403-C7



C-1408-C5



C-5003F-C4



C-6260-C6



D-301-C10



D-870-C4



D-872-C2



D-1001M-C9



D-1403-C8



D-1408-C1



D-5003F-C3



D-6260-C5



E-301-C1



E-870-C5



E-872-C2



E-1001M-C4



E-1403-C9



E-1408-C6



E-5003F-C10



E-6260-C3



F



F-301-C4



F-870-C10



F-872-C2



F-1001M-C6



F-1403-C5



F-1408-C7



F-5003F-C3



F-6260-C9



G



G-301-C7



G-870-C6



G-872-C4



G-1001M-C3



G-1403-C10



G-1408-C2



G-5003F-C9



G-6260-C1



H



H-301-C9



H-870-C3



H-872-C8



H-1001M-C5



H-1403-C1



H-1408-C10



H-5003F-C7



H-6260-C6



I



I-301-C5



I-870-C9



I-872-C3



I-1001M-C1



I-1403-C4



I-1408-C6



I-5003F-C8



I-6260-C10



Use example
使用例图

镜盒

CASES

4 - 21

清洗液

SPRAY

22 - 24

镜布

MICROFIBER

25 - 31

纸袋

BAGS

32 - 33

设备

EQUIPMENT

35 - 65

设备配件

EQUIPMENT

ACCESSORIES

66 - 94

钳子

PILERS

95 - 102

螺丝

SCREWS

103 - 105

眼镜配件

GLASSES

ACCESSORIES

106 - 121

镜绳

GLASSES

CHAINS

122 - 126

道具

PROPERTY

128 - 137

镜架

FRAME

139 - 146

镜片

LENS

148 - 153

礼品

GIFTS

155 - 157

- 镜盒
CASES
- 4 - 21
- 清洗液
SPRAY
- 22 - 24
- 镜布
MICROFIBER
- 25 - 31
- 纸袋
BAGS
- 32 - 33
- 设备
EQUIPMENT
- 35 - 65
- 设备配件
EQUIPMENT
ACCESSORIES
- 66 - 94
- 钳子
PLIERS
- 95 - 102
- 螺丝
SCREWS
- 103 - 105
- 眼镜配件
GLASSES
ACCESSORIES
- 106 - 121
- 镜绳
GLASSES
CHAINS
- 122 - 126
- 道具
PROPERTY
- 128 - 137
- 镜架
FRAME
- 139 - 146
- 镜片
LENS
- 148 - 153
- 礼品
GIFTS
- 155 - 157



MG001
Plastic 50mm



MG002
Plastic 60mm



MG003
Plastic 75mm



MG004
Plastic 90mm



MG005
Plastic 60mm



MG006
Plastic 75mm



MG007
Plastic 90mm



MG008
Plastic with light 50mm



MG009
Metal 60mm



MG010
Metal 75mm



MG011
Metal 90mm



MG012
Metal 30x-21mm



MG013
Metal 60mm



MG014
Metal 80mm

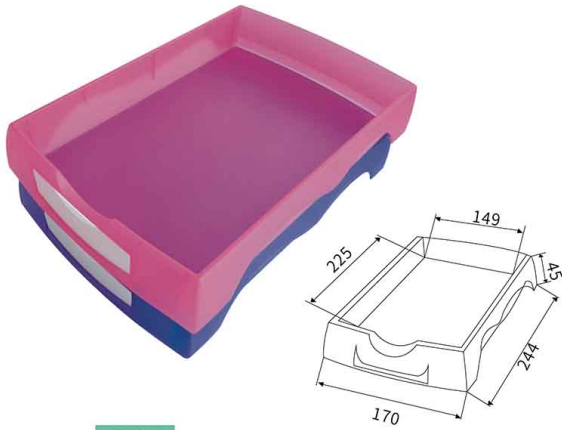

RTB-1

Inner Size : 40×149×225mm
Weight : 157g

Outside Size : 45×170×244mm
Color :

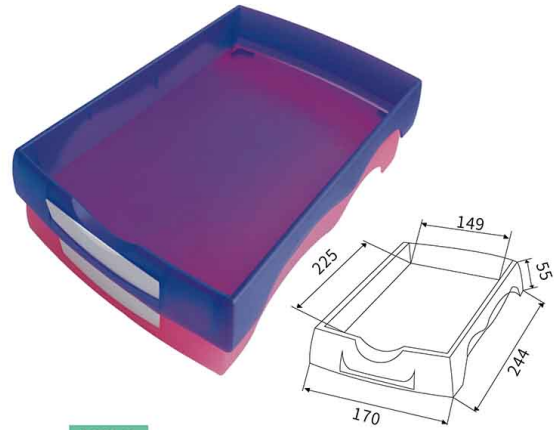

RTB-2

Inner Size : 40×149×225mm
Weight : 157g

Outside Size : 55×170×244mm
Color :

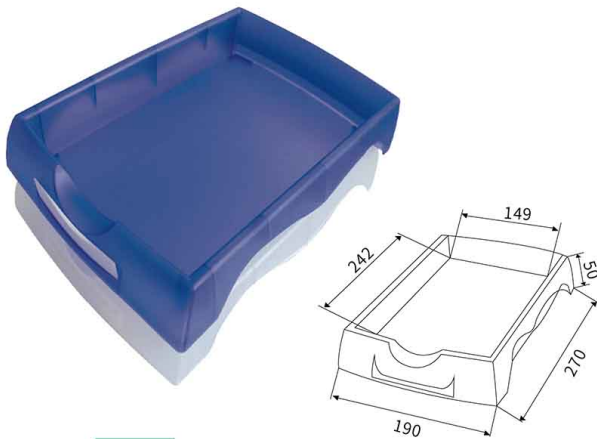

RTB-3

Inner Size : 44×149×242mm
Weight : 196g

Outside Size : 50×190×270mm
Color :

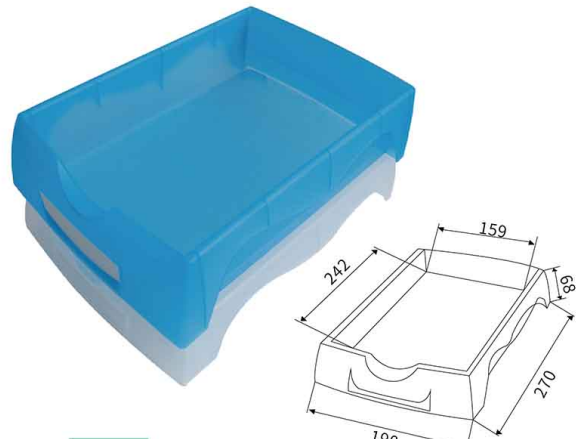

RTB-4

Inner Size : 63×159×242mm
Weight : 210g

Outside Size : 68×190×270mm
Color :

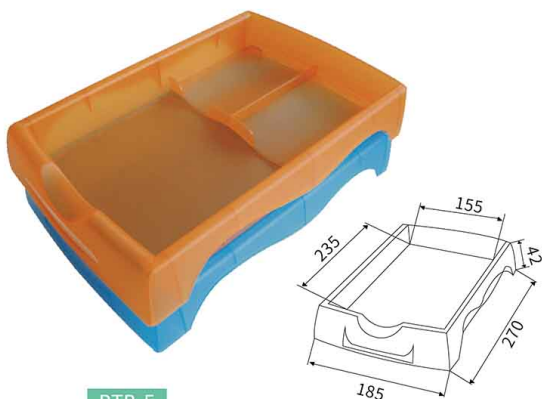

RTB-5

Inner Size : 42×155×235mm
Weight : 190g

Outside Size : 44×185×270mm
Color :

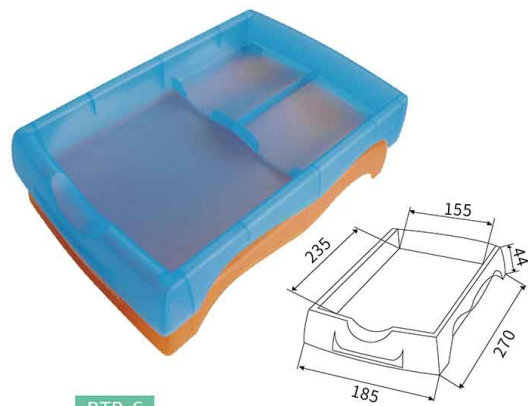

RTB-6

Inner Size : 42×155×235mm
Weight : 190g

Outside Size : 44×185×270mm
Color :

镜盒 CASES
4 - 21
清洗液 SPRAY
22 - 24
镜布 MICROFIBER
25 - 31
纸袋 BAGS
32 - 33
设备 EQUIPMENT
35 - 65
设备配件 EQUIPMENT ACCESSORIES
66 - 94
钳子 PLIERS
95 - 102
螺丝 SCREWS
103 - 105
眼镜配件 GLASSES ACCESSORIES
106 - 121
镜绳 GLASSES CHAINS
122 - 126
道具 PROPERTY
128 - 137
镜架 FRAME
139 - 146
镜片 LENS
148 - 153
礼品 GIFTS
155 - 157

镜盒

CASES

4 - 21

清洗液

SPRAY

22 - 24

镜布

MICROFIBER

25 - 31

纸袋

BAGS

32 - 33

设备

EQUIPMENT

35 - 65

设备配件

EQUIPMENT

ACCESSORIES

66 - 94

钳子

PILERS

95 - 102

螺丝

SCREWS

103 - 105

眼镜配件

GLASSES

ACCESSORIES

106 - 121

镜绳

GLASSES

CHAINS

122 - 126

道具

PROPERTY

128 - 137

镜架

FRAME

139 - 146

镜片

LENS

148 - 153

礼品

GIFTS

155 - 157



OA016

小号蓝光笔 small blue light pen



OA083

小号蓝光笔 small blue light pen



OA084

小号蓝光笔 small blue light pen



OA017-B

测变色手电筒 photochromic lens torch tester



OA017

蓝光笔满天星光效 blue light pen with star light



OA017-A

蓝光笔单束光 blue light pen with single beam



OA024

普通笔灯 ordinary pen light



OA024-A

普通笔灯 ordinary pen light



OA025

金属拉笔灯 metal pull-pen light



OA085

普通笔灯 ordinary pen light



OA025-A

塑料笔灯 plastic pen light



OA087

普通笔灯 ordinary pen light



OA086

普通笔灯 ordinary pen light



OA018

金属拉笔 metal pull-pen



OA019

金属拉笔 metal pull-pen



OA022

金属拉笔 metal pull-pen



OA023

金属拉笔 metal pull-pen



OA047A

挡板 splash board



OA047

挡板 splash board



OA046

大号挡板 big splash board



OA059



OA060



OA079



OA079-A



OA080



OA080-A



OA080-B



OA080-C



OA080-D



OA080-E



OA080-F



OA080-G



OA080-H



OA081



OA082

镜盒
CASES

4 - 21

清洗液
SPRAY

22 - 24

镜布
MICROFIBER

25 - 31

纸袋
BAGS

32 - 33

设备
EQUIPMENT

35 - 65

设备配件
EQUIPMENT
ACCESSORIES

66 - 94

钳子
PLIERS

95 - 102

螺丝
SCREWS

103 - 105

眼镜配件
GLASSES
ACCESSORIES

106 - 121

镜绳
GLASSES
CHAINS

122 - 126

道具
PROPERTY

128 - 137

镜架
FRAME

139 - 146

镜片
LENS

148 - 153

礼品
GIFTS

155 - 157

镜盒
CASES

4 - 21

清洗液
SPRAY

22 - 24

镜布
MICROFIBER

25 - 31

纸袋
BAGS

32 - 33

设备
EQUIPMENT

35 - 65

设备配件
EQUIPMENT
ACCESSORIES

66 - 94

钳子
PLIERS

95 - 102

螺丝
SCREWS

103 - 105

眼镜配件
GLASSES
ACCESSORIES

106 - 121

镜绳
GLASSES
CHAINS

122 - 126

道具
PROPERTY

128 - 137

镜架
FRAME

139 - 146

镜片
LENS

148 - 153

礼品
GIFTS

155 - 157



5m / 1.2mm 5m / 1.3mm

OA007 OA007-1
垫丝 sadler 垫丝 sadler



OA008
油漆笔 paint



XL 12mm L 6-7mm M 5-6mm S 4-5mm

OA010
防过敏套 Anti allergy sleeve



1.0 / 1.5 / 2.0 / 2.5 / 3.0 / 3.5 / 4.0

OA010-B
防过敏套 Anti allergy sleeve



64 × 54 × 1mm

OA011
白模板 white pattern

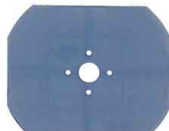

64 × 54 × 1mm

OA012
蓝模板 blue pattern



64 × 54 × 1mm

OA013
黄模板 yellow pattern



68.5 × 58.5 × 1.5mm

OA013A
大号模板 big size pattern



L M S

OA038
串珠 a string of beads



S



M



L

OA039
眼罩 eye mask



OA039-B
眼贴 eye mask



有医疗资质可供医院

OA039-C
眼贴 eye mask



有医疗资质可供医院

OA039-A
眼罩 eye mask



OA039-E
卡通眼贴 cartoon eye mask



OA039-D
聚散珠 beads



OA044
卡通眼罩 eye mask



OA040
焊台 soldering station



OA040-A
焊丝 welding stick



OA045
焊枪 welding gun



OA088
焊膏 soldering paste



OA052

盒装染色粉 dye packets

Model No.	Color 颜色	Model No.	Color 颜色
C1001	Gray灰色	C1017	Violet深紫色
C1002	Black Gray黑色	C1018	Pink粉红色
C1003	Purple Gray紫灰色	C1019	Red大红色
C1004	Brown褐色	C1020	Burgundy酒红色
C1005	Coffee 咖啡色	C1021	Blue天蓝色
C1006	Dark Brown黑褐色	C1022	Navy Blue深蓝色
C1007	Tea 茶色	C1023	Midnight blue深夜蓝
C1008	Grass Green草绿色	C1024	Yellow黄色
C1009	Rose Red玫红色	C1025	Nightvision Yellow夜视黄
C1010	Lake Blue湖蓝色	C1026	Orange橙色
C1015	G15墨绿色	C1027	Green绿色
C1016	Purple紫色	C1028	Blue Green蓝绿色



OA055

瓶装染色粉 dye packets

Model No.	Color 颜色
C2001	Brown棕色
C2002	Dark Brown黑茶色
C2003	Black黑色
C2004	Blue蓝色
C2005	Red红色
C2006	Purple紫色
C2007	Dark green墨绿色
C2008	Yellow黄色
C2009	Gray灰色
C2010	Pink粉红色
C2011	Green绿色



OA056

鱼丝线 wire line

Size尺寸

	φ0.5(20m)
	φ0.6(20m)
	0.47 (10m)
	0.51 (10m)
	0.6 (10m)
	1.0 (5m)
	1.2 (5m)
	M1.2 (5m)



OA054-A

车载眼镜夹 sunglasses clip



OA054-B

车载眼镜夹 sunglasses clip



OA064

太阳能转盘 solar display



OA065

太阳能转盘 solar display



OA065A

太阳能转盘 solar display

镜盒 CASES	4 - 21
清洗液 SPRAY	22 - 24
镜布 MICROFIBER	25 - 31
纸袋 BAGS	32 - 33
设备 EQUIPMENT	35 - 65
设备配件 EQUIPMENT ACCESSORIES	66 - 94
钳子 PLIERS	95 - 102
螺丝 SCREWS	103 - 105
眼镜配件 GLASSES ACCESSORIES	106 - 121
镜绳 GLASSES CHAINS	122 - 126
道具 PROPERTY	128 - 137
镜架 FRAME	139 - 146
镜片 LENS	148 - 153
礼品 GIFTS	155 - 157

镜盒
CASES

4 - 21

清洗液
SPRAY

22 - 24

镜布
MICROFIBER

25 - 31

纸袋
BAGS

32 - 33

设备
EQUIPMENT

35 - 65

设备配件
EQUIPMENT
ACCESSORIES

66 - 94

钳子
PLIERS

95 - 102

螺丝
SCREWS

103 - 105

眼镜配件
GLASSES
ACCESSORIES

106 - 121

镜绳
GLASSES
CHAINS

122 - 126

道具
PROPERTY

128 - 137

镜架
FRAME

139 - 146

镜片
LENS

148 - 153

礼品
GIFTS

155 - 157



OA061

大(L)超声波清洗机二合一
ultrasonic cleaner 2 in 1



OA062

小(S)超声波清洗机五合一
ultrasonic cleaner 5 in 1



OA063

超声波清洗机三合一
ultrasonic cleaner 3 in 1



OA067

按摩仪 massager



OA057

视姿宝 adjuster

